

NUTP5 Series

24V Hy-Brite LED Tape Light

Source: 4.25W/ft. LED
375lm/ft.

Type

Project

Catalog No.

Notes

PRODUCT DESCRIPTION

Hy-Brite LED Tape is the perfect solution when you need more light than Standard LED Tape but less than high output LED Tape. Producing 200 lumens, the Hy-Brite uses the same connectors and accessories as the High Output LED Tape. The low profile tape is the ideal for coves, architectural details, under and in cabinets, toe kicks, and back lighting.

FEATURES

- Available in 16' roll, 12" section, and 4" section
- 24V DC system
- 375 lumens per foot
- Single color illumination in three color temperatures (2700K, 3000K or 4200K)
- Separable every 12", easily disconnected and connected without soldering
- Field cuttable every 4" or 4 LEDs
- Easy to install; pre-applied 3M™ tape or 15 acrylic mounting clips (included with roll)
- No soldering or additional wiring is required

INCLUDED WITH EVERY 16' ROLL

(1) 16' Tape Light Roll with 12" separable sections, (15) Acrylic Mounting Clips with screws [NATHR-680], and (1) 12" Power Line Interconnector [NAHO-609].

SPECIFICATION

Construction: The silicone encapsulated tape can be cut every 4" or 4 LEDs at marked intervals. Cutting does not effect circuit (shrink wrap tube included for concealment). LED Tape Light is also separable every 12", each connection has pre-installed shrink wrap around power connections to ensure listing. Simply slice the clear shrink wrap at each electrical connection, and separate pieces. This eliminates soldering when using partial rolls. Each roll or kit comes with 12" power line connector [NAHO-609].

Mounting: Each Tape Light includes pre-applied 3M™ adhesive tape for simple installation. Optional channels and clear acrylic clips are available.

LIMITATIONS

- Not rated or warranted for enclosed applications
- Tape light and most accessories are not rated for in-wall installation (NATL-W16-2 is rated for in-wall installations)
- Do not install in where LED chips are exposed to direct sunlight, as damage to the phosphor will occur

ELECTRICAL

Input Voltage: 24V

Lumens / Wattage: 375lm / 4.25W per foot

Color Temperature: 2700K, 3000K or 4200K

Color Rendering Index: 90+ CRI

Operating Temperature: -25°C to 45°C

Dimming: Dimmable with Dimmable LED Driver

Maximum Run Length: 25'

LABELS AND LISTINGS

- cULus Listed for Damp Locations
- 3-Year Limited Warranty



PRODUCT IMAGES & DIMENSIONS

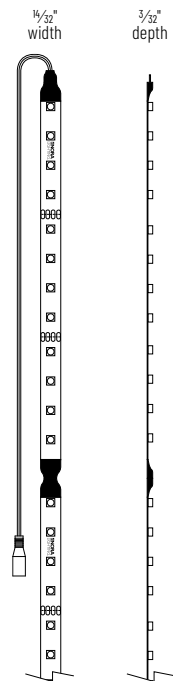

24V Hy-Brite LED Tape Light

Length	CCT / CRI	Section Length
NUTP5-W16LED = 16' Roll	927 = 2700K / 90 CRI	(blank) = 16' Roll
	930 = 3000K / 90 CRI	
	942 = 4200K / 90 CRI	
NUTP5-WLED = Section	927 = 2700K / 90 CRI	/4 = 4" Section
	930 = 3000K / 90 CRI	/12 = 12" Section
	942 = 4200K / 90 CRI	

Example: **NUTP5-WLED930/12** = 12" 24V Hy-Brite LED Tape Light, 3000K / 90 CRI

NUTP5 Series

24V Hy-Brite LED Tape Light Accessories

Type

Project

Catalog No.

Notes



"Y" Splitter Cable

NAHO-600W

Allows splitting the Tape Light from a run or driver, into two separate runs.

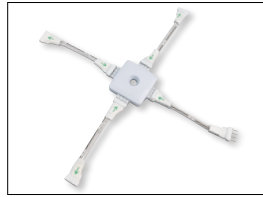

X-Splitter Cable

NAHO-601W

Allows splitting the Tape Light from a run or driver, into three separate runs.

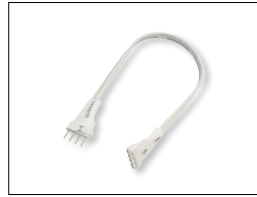

Interconnection Cable

NAHO-602W 2" Cable
NAHO-606W 6" Cable
NAHO-618W 18" Cable
NAHO-636W 36" Cable
NAHO-672W 72" Cable

Allows easy linking of two Tape Light sections. Cables are flexible and can be moved in any direction, or be joined together for custom lengths.



Power Line Interconnector

NAHO-609W 12" Cable

Connects any Tape Light run to a driver. (1) Power line interconnector is included with every Tape Light roll.

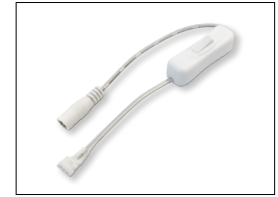

Power Line Interconnector with On/Off Switch

NAHO-611W

Allows individual switching on any Tape Light run, and connect LED Tape Light run directly to LED Driver.



Shrink Wrap Tube

NATL-400 Pack of 5

Seals connection made in the field. Necessary to maintain cULus listing. Two shrink wrap tubes are included with every Tape Light roll and section.



End Cap

NATL-403 Black
NATL-403W White

Covers open end of Tape Light.



Clear Acrylic Mounting Clips

NATHR-685 Pack of 15

Use in conjunction with adhesive backing to attach Tape Light to a surface. Pack of 15 clear acrylic mounting clips are included with every Tape Light roll.



4' Channel

NATHR-680 Aluminum

Mounts Tape Light to various surfaces. Field cuttable.



Mounting Clips for Channels

NATL-CMC Pack of 15

Mounting clips for NATL-C23, NATL-C24 and NATL-C27. Pack includes 15 mounting clips.

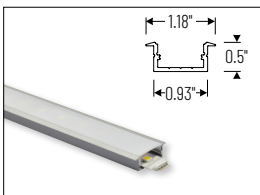

4' Shallow Recessed Channel

NATL-C23A Aluminum

Used to mount tape light recessed in a surface. Plastic diffuser and end caps included. Field cuttable.

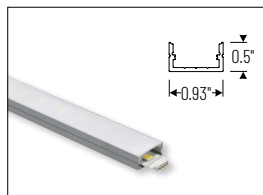

4' Shallow Channels

NATL-C24A Aluminum
NATL-C24B Black
NATL-C24W White

Used to mount tape light to various surfaces. Plastic diffuser and end caps included. Field cuttable.

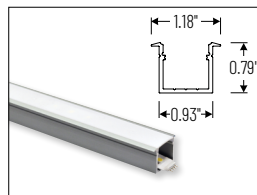

4' Deep Recessed Channel

NATL-C25A Aluminum

Used to mount tape light recessed in a surface. Plastic diffuser and end caps included. Field cuttable.

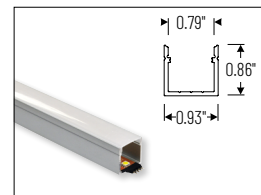

4' Deep Channels

NATL-C26A Aluminum
NATL-C26W White

Used to mount tape light to various surfaces. Plastic diffuser and end caps included. Field cuttable.

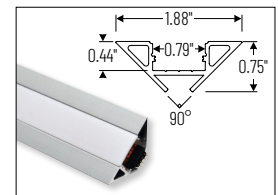

4' Corner Channels

NATL-C28A Aluminum
NATL-C28B Black
NATL-C28W White

Plastic diffuser and End caps included. Field cuttable

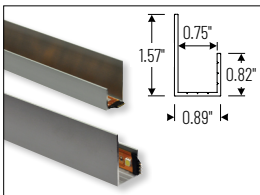

4' J-Style Channel

NATL-C27A Aluminum

Used to mount tape light to various surfaces. Field cuttable.

NUTP5 Series

24V Hy-Brite LED Tape Light Drivers & Accessories

Type

Project

Catalog No.

Notes



Direct Plug-In LED Driver

NATL-524W 24V 24W
NATL-545W 24V 45W

Input Voltage: 120V
Cable Length: 6'

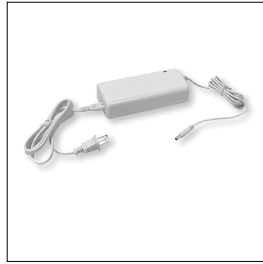

Direct Plug-In LED Driver

NATL-596W 24V 96W

Input Voltage: 120V
Input Wire: 44" Cord and Plug
Output Wire: 58" Power line connector



Class II Hardwire LED Driver

NATL-5100HW 24V 81.6W

Input Voltage: 120-240V
Dimming: Non-Dimmable
Includes: 10' Power Line Connector



Class II Universal Dimming Driver

NPSU-60W/24 60W
NPSU-96W/24 96W
NPSU-3X96W/24 3x 96W

Input Voltage: 110-277V
Dimming: Triac, ELV, MLV, 0-10V, PWM
Note: Power Line Connector(s) not included



Class II Hardwire LED Driver
ELV Dimming

NATLED-5040HW 24V 40W
NATLED-5075HW 24V 75W

Input Voltage: 120V
Dimming: ELV
Includes: 10' Power Line Connector



Class II Hardwire LED Driver
MLV Dimming

NMT-48/24C2D1 48W

Input Voltage: 120V
Dimming: Magnetic Low Voltage
Includes: 10' Power Line Connector



Class II Hardwire LED Driver
with Breakers, MLV Dimming

NMT-303/24C2D1 120V input
NMT-303/24C2D2 277V input

Input Voltage: 120V or 277V
Dimming: Magnetic Low Voltage
Breakers: (3) 100W
Note: Power Line Connector(s) not included



Class II Hardwire LED Driver
with Regulator, MLV Dimming

NMTD-60/24D 24V 60W
NMTD-96/24D 24V 96W

Input Voltage: 120-277V
Dimming: Magnetic Low Voltage
Regulator: Integral regulator for constant current and voltage
Includes: 10' Power Line Connector



NEXUS® All-in-One LED Driver and
Dimmer

NATL-SWEX60/24A 24V 60W
NATL-SWEX100/24A 24V 100W

Input Voltage: 120V
Dimming: Integral Dimmer
Description: Eliminates the driver and allows 120V input and 24V output from a single gang box. 100-5% dimming and on/off switch.



Power Line Connector

NATL-10 10' Power Line
NATL-30 30' Power Line

For use with Class II drivers. Carries output from driver, requires power line interconnectors.

NATL-302W 5" Splitter

Splits power line connector into two separate leads, requires power line cable.



Touch Dimmer with Memory

NATL-518W

72W max., no power fail memory, touch on/off and hold to dim.



Low Voltage Splice Box

NATL-415W

Use to join low voltage lead to power line connector.



Terminal Block

NATL-407 4-Way
2-3/8"L x 1-1/8"W x 7/8"D

NATL-408 8-Way
4"L x 1-1/8"W x 7/8"D



Wire Clip, Plastic - 10pk

NATL-404W J-Clip
NATL-405W Over the Wire
NATL-406W Square Clip



2' Wire Raceway

NATL-422B Black
NATL-422W White

Field-cutable plastic. Includes wire channel with double faced tape and cover.

NUTP5 Series

24V Hy-Brite LED Tape Light - Sample Layout

Type _____
 Project _____
 Catalog No. _____
 Notes _____

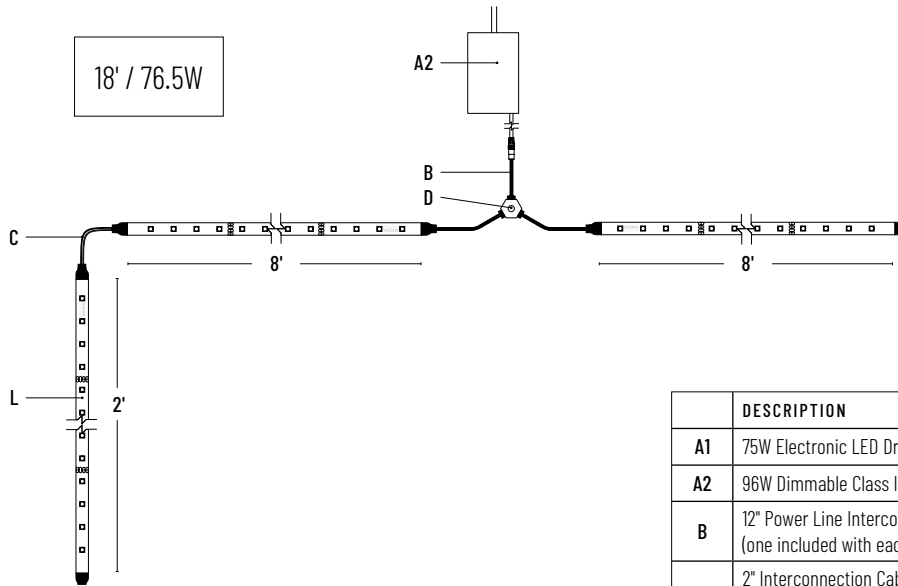
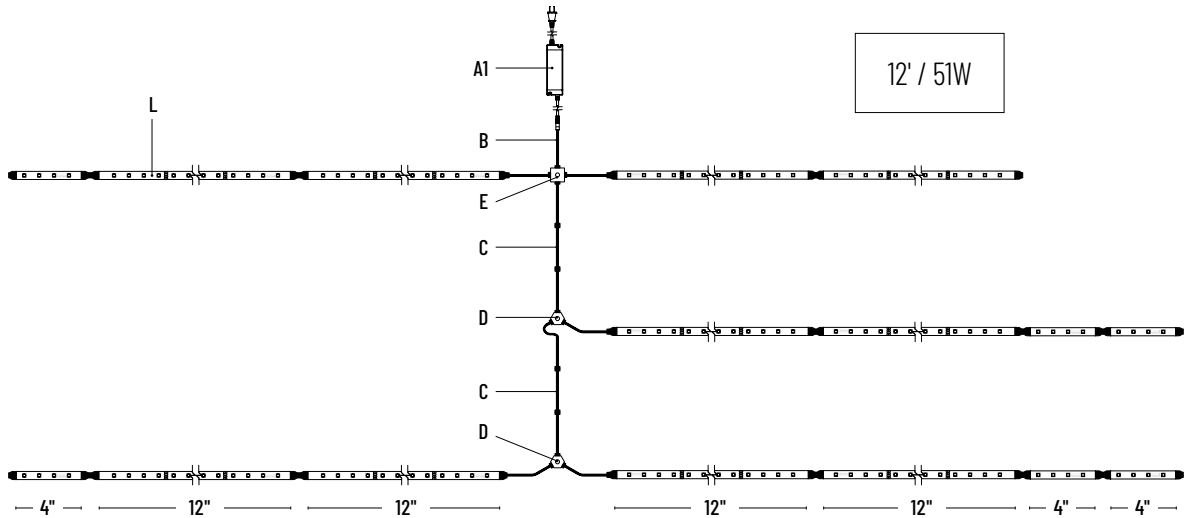

	DESCRIPTION	ITEM #
A1	75W Electronic LED Driver	NATLED-5075HW
A2	96W Dimmable Class II Power Supply	NMTD-96/24D
B	12" Power Line Interconnector (one included with each Tape Light roll)	NAHO-609W
C	2" Interconnection Cable 6" Interconnection Cable 18" Interconnection Cable 36" Interconnection Cable 72" Interconnection Cable	NAHO-602W NAHO-606W NAHO-618W NAHO-636W NAHO-672W
D	"Y" Splitter Cable	NAHO-600W
E	"X" Splitter Cable	NAHO-601W
L	4" Hy-Brite LED Tape Light 12" Hy-Brite LED Tape Light 16' Hy-Brite LED Tape Light Roll	NUTP5-WLED(CCT)/4 NUTP5-WLED(CCT)/12 NUTP5-W16LED(CCT)

*Note: All drivers require power line interconnector to connect to tape.