

# NMP2-A

## 24V Adjustable Josh LED Puck Light

Source: 3.5W LED  
300lm

Type

Project

Catalog No.

Notes

### PRODUCT DESCRIPTION

Adjustable Josh, a slim light disk LED system for accent, under cabinet, in-cabinet, niche, and jewelry cases, and other applications with limited space. These low-profile fixtures can be spaced together to provide excellent and even illumination on all surfaces. The Josh pucks does not produce a diode image and can be recessed or surface mounted. Combined with ultra low-profile housing, Josh offers unique features and a great ease of installation. LED technology eliminates forward heat from the fixture, also no UV or infrared rays to harm artwork, retail displays or heat sensitive foods. The luminaire produces more light than a traditional 20 watt xenon or halogen puck while consuming only 3.5 watts each puck.

### FEATURES

- 18° Adjustment
- 24V Low Voltage System
- 2700K, 3000K, 3500K or 4000K @ 90+ CRI
- Recessed or surface mount
- Easy installation
- Dimmable with power supply
- 12" to 48" extension cables accessory available
- No flicker delay or warm up like compact fluorescent products
- No UV light or infrared wavelengths
- 5-Year Limited Warranty
- Each puck comes with a 72" wire and connector

### ELECTRICAL

**Input Voltage:** 24VDC

**Lumens / Wattage:** 300lm / 3.5W

**Color Temperature:** 2700K, 3000K, 3500K, 4000K

**Color Rendering Index:** 90+ CRI

**Operating Temperature:** 0°C to 40°C

**Cord Length:** 72" wire and connector

**Maximum # of Units Per Interconnect:** Six luminaires can be connected to interconnect (NMPA-6P-24). Each luminaire must connect to interconnect, cannot daisy chain.

**Life Expectancy:** 50,000 hours

**Dimming:** Specified by driver

**Cabinet Installation:** Up to three puck lights may be installed in an enclosed cabinet size of 3.5" x 11.5" x 12"

### LABELS AND LISTINGS

- cULus Listed for Damp Location
- cULus Listed for under-cabinet and cabinet use
- 5-Year Limited Warranty
- RoHS compliant



### PRODUCT IMAGES AND DIMENSIONS

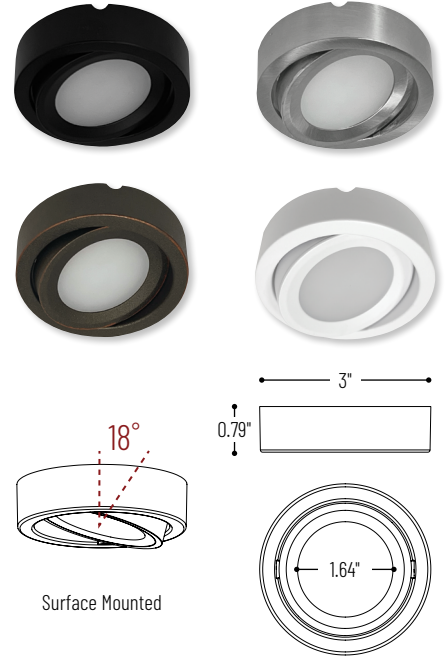

**NMP2-A**  
Adjustable Josh LED Puck Light



**NMP2-AEC**  
Recessed Flange Accessory

### 24V Adjustable Josh LED Puck Light

Color Temperature	Finish
<b>NMP2-A27</b> = 2700K	<b>B</b> = Black
<b>NMP2-A30</b> = 3000K	<b>BZ</b> = Bronze
<b>NMP2-A35</b> = 3500K	<b>BN</b> = Brushed Nickel
<b>NMP2-A40</b> = 4000K	<b>W</b> = White

### Recessed Flange Accessory

Accessory Type	Finish
<b>NMP2-AEC</b> = Recessed Flange	<b>B</b> = Black
	<b>BZ</b> = Bronze
	<b>BN</b> = Brushed Nickel
	<b>W</b> = White

Example: **NMP2-A30W** = 24V Adjustable Josh LED Puck Light, 3000K, White Finish

# NMP2-A

## 24V Adjustable Josh LED Puck Light Accessories

Type

Project

Catalog No.

Notes



6-Port Power Line Interconnect

**NMPA-6P-24B** Black  
**NMPA-6P-24W** White

Terminal block connects up to six LED Josh Puck lights to a Nora driver. Includes 24" cord with RCA jack.



Extension Cable

**NMPA-EW-12** 12"  
**NMPA-EW-24** 24"  
**NMPA-EW-36** 36"  
**NMPA-EW-48** 48"

Finish: Black (B), White (W)

Used to extend the length of the cable from the puck to the terminal block. Linkable up to 110'.



2' Wire Raceway

**NATL-422B** Black  
**NATL-422W** White

Field-cuttable plastic. Includes wire channel with double faced tape and cover.

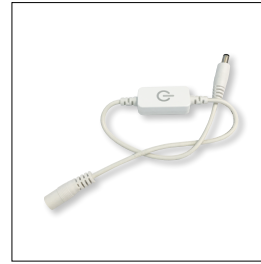

In-Line Touch Dimmer

**NATL-518W**

72W max., no power fail memory, touch on/off and hold to dim.



Direct Plug-In LED Driver

**NATL-524W** 24V 24W  
**NATL-545W** 24V 45W

**Input Voltage:** 120V  
**Cable Length:** 6'

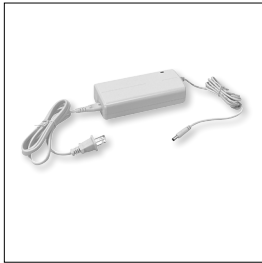

Direct Plug-In LED Driver

**NATL-596W** 24V 96W

**Input Voltage:** 120V  
**Input Wire:** 44" Cord and Plug  
**Output Wire:** 58" Power line connector



Class II Hardwire LED Driver

**NATL-5100HW** 24V 81.6W

**Input Voltage:** 120-240V  
**Dimming:** Non-Dimmable  
**Includes:** 10' Power Line Connector



Class II Universal Dimming Driver

**NPSU-60W/24** 60W  
**NPSU-96W/24** 96W  
**NPSU-3X96W/24** 3x 96W

**Input Voltage:** 110-277V  
**Dimming:** Triac, ELV, MLV, 0-10V, PWM  
**Note:** Power Line Connector(s) not included



Class II Hardwire LED Driver  
ELV Dimming

**NATLED-5040HW** 24V 40W  
**NATLED-5075HW** 24V 75W

**Input Voltage:** 120V  
**Dimming:** ELV  
**Includes:** 10' Power Line Connector



Class II Hardwire LED Driver  
MLV Dimming

**NMT-48/24C2D1** 48W

**Input Voltage:** 120V  
**Dimming:** Magnetic Low Voltage  
**Includes:** 10' Power Line Connector



Class II Hardwire LED Driver with Regulator, MLV Dimming

**NMTD-60/24D** 24V 60W  
**NMTD-96/24D** 24V 96W

**Input Voltage:** 120-277V  
**Dimming:** Magnetic Low Voltage  
**Regulator:** Integral regulator for constant current and voltage  
**Includes:** 10' Power Line Connector



Power Line Connector

**NATL-10** 10' Power Line  
**NATL-30** 30' Power Line

For use with Class II drivers. Carries input from driver, requires power line interconnectors.

**NATL-302W** 5" Splitter

Splits power line connector into two separate leads, requires power line cable.



Low Voltage Splice Box

**NATL-415W**

Use to join low voltage lead to low voltage power line connector or interconnector.



Terminal Block

**NATL-407** 4-Way  
2-3/8"L x 1-1/8"W x 7/8"D  
**NATL-408** 8-Way  
4"L x 1-1/8"W x 3/8"D



Wire Clip, Plastic - 10pk

**NATL-404W** J-Clip  
**NATL-405W** Over the Wire  
**NATL-406W** Square Clip

# NMP2-A Sample Layout

## 24V Adjustable Josh LED Puck Light

Type \_\_\_\_\_  
 Project \_\_\_\_\_  
 Catalog No. \_\_\_\_\_  
 Notes \_\_\_\_\_

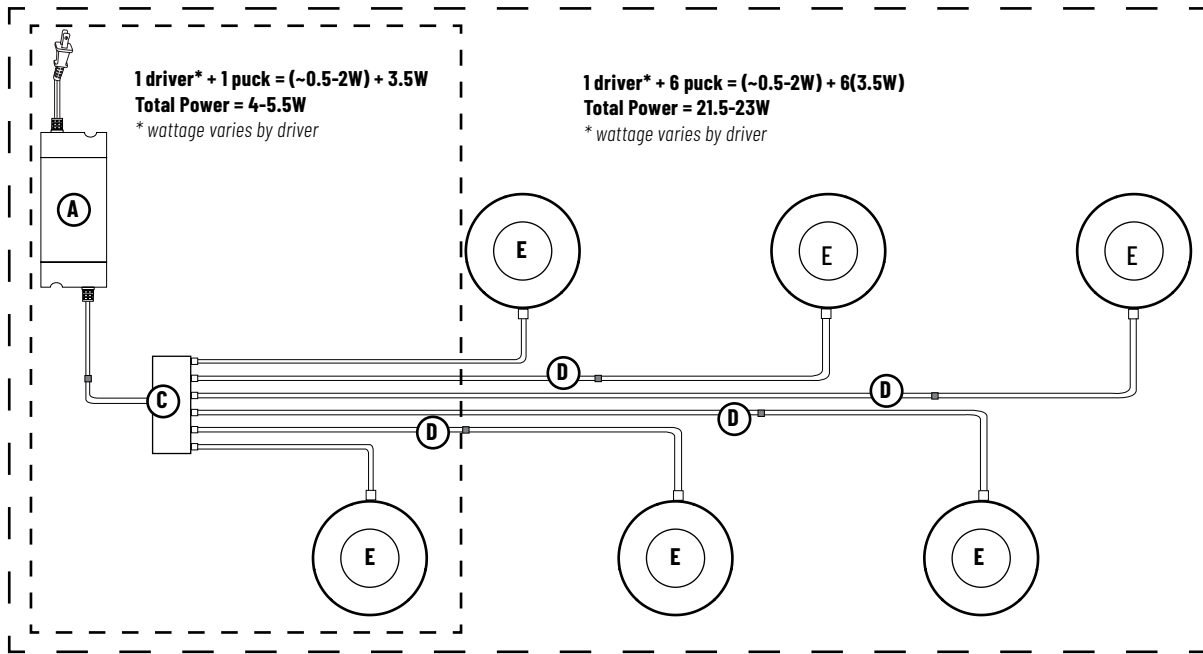

A	<b>NATL-545W</b>	24V 45W Direct Plug-In Driver
A2	<b>NMTD-60/24D</b>	24V 60W Dimmable Class II Power Supply
B	<b>NALTL-10</b>	10' Power Line Connector
C	<b>NMPA-6P-24</b>	Power Line Interconnect with 6-port terminal block
D	<b>NMPA-EW-12B/W</b> <b>NMPA-EW-24B/W</b> <b>NMPA-EW-36B/W</b> <b>NMPA-EW-48B/W</b>	12" Extension Cable 24" Extension Cable 36" Extension Cable 48" Extension Cable
E	<b>NMP2-A</b>	24V Adjustable Josh LED Puck Light

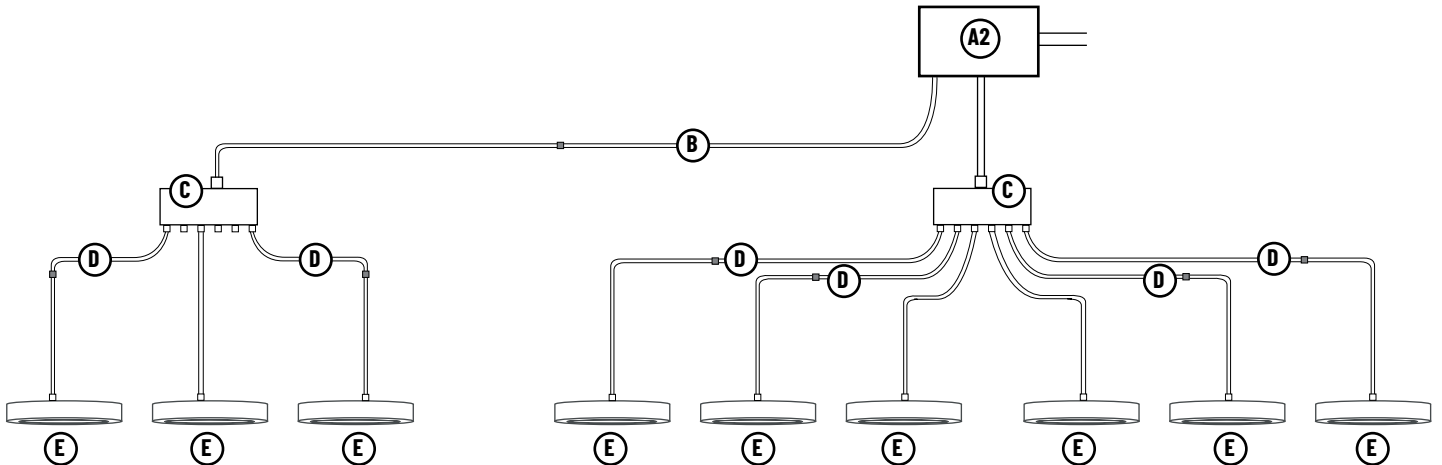

# PHOTOMETRICS

## 24V Adjustable Josh LED Puck Light

Type

Project

Catalog No.

Notes

### Test Information

Test Number: NTS178R1  
 Part Number: NMP2-A27W  
 Beam Spread: 113° Wide Flood  
 Lumens: 291lm  
 Wattage: 5.27W  
 Efficacy: 55lpw  
 CCT / CRI: 2700K / 90 CRI  
 Spacing Criteria (0°-180°): 1.26  
 Spacing Criteria (90°-270°): 1.26

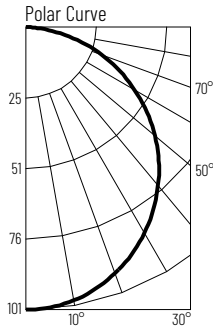

### Illuminance at a Distance

Distance from Luminaire	FC at Nadir	Beam Diameter
4'	6.3fc	12"-2"
6'	2.8fc	18"-4"
8'	1.6fc	24"-5"
10'	1.0fc	30"-6"
12'	0.7fc	36"-7"

### Zonal Lumen Summary

Zone	Lumens	% Luminaire
0-30	79	27.0
0-40	129	44.2
0-60	228	78.4
0-90	291	100
90-180	0	0
0-180	291	100

### Candela Table

Vertical Angles	Candela
0	101
5	101
15	97
25	91
35	80
45	68

### Test Information

Test Number: NTS179R1  
 Part Number: NMP2-A30W  
 Beam Spread: 113° Wide Flood  
 Lumens: 312lm  
 Wattage: 5.42W  
 Efficacy: 58lpw  
 CCT / CRI: 3000K / 90 CRI  
 Spacing Criteria (0°-180°): 1.26  
 Spacing Criteria (90°-270°): 1.26

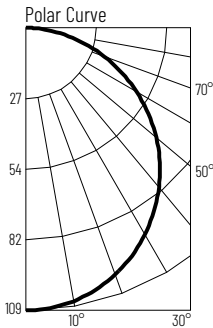

### Illuminance at a Distance

Distance from Luminaire	FC at Nadir	Beam Diameter
4'	6.8fc	12"-2"
6'	3.0fc	18"-4"
8'	1.7fc	24"-5"
10'	1.1fc	30"-6"
12'	0.8fc	36"-7"

### Zonal Lumen Summary

Zone	Lumens	% Luminaire
0-30	84	27
0-40	138	44.2
0-60	245	78.4
0-90	312	100
90-180	0	0
0-180	312	100

### Candela Table

Vertical Angles	Candela
0	109
5	108
15	105
25	97
35	86
45	72

### Test Information

Test Number: NTS180R1  
 Part Number: NMP2-A35W  
 Beam Spread: 113° Wide Flood  
 Lumens: 307lm  
 Wattage: 5.2W  
 Efficacy: 59lpw  
 CCT / CRI: 3500K / 90 CRI  
 Spacing Criteria (0°-180°): 1.26  
 Spacing Criteria (90°-270°): 1.26

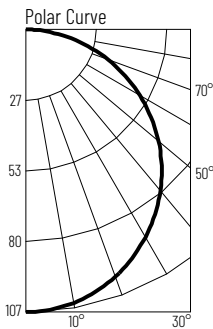

### Illuminance at a Distance

Distance from Luminaire	FC at Nadir	Beam Diameter
4'	6.0fc	12"-2"
6'	3.0fc	18"-4"
8'	1.7fc	24"-5"
10'	1.1fc	30"-6"
12'	0.7fc	36"-7"

### Zonal Lumen Summary

Zone	Lumens	% Luminaire
0-30	83	27
0-40	136	44.2
0-60	241	78.4
0-90	307	100
90-180	0	0
0-180	307	100

### Candela Table

Vertical Angles	Candela
0	107
5	107
15	103
25	96
35	85
45	71

### Test Information

Test Number: NTS181R1  
 Part Number: NMP2-A40W  
 Beam Spread: 113° Wide Flood  
 Lumens: 317lm  
 Wattage: 5.19W  
 Efficacy: 61lpw  
 CCT / CRI: 4000K / 90 CRI  
 Spacing Criteria (0°-180°): 1.26  
 Spacing Criteria (90°-270°): 1.26

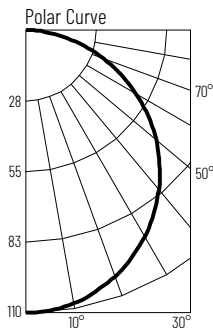

### Illuminance at a Distance

Distance from Luminaire	FC at Nadir	Beam Diameter
4'	6.9fc	12"-2"
6'	3.1fc	18"-4"
8'	1.7fc	24"-5"
10'	1.1fc	30"-6"
12'	0.77fc	36"-7"

### Zonal Lumen Summary

Zone	Lumens	% Luminaire
0-30	86	27
0-40	140	44.2
0-60	249	78.4
0-90	317	100
90-180	0	0
0-180	317	100

### Candela Table

Vertical Angles	Candela
0	110
5	110
15	106
25	99
35	88
45	74